



ZA-6th/7th Motherboard

User Manual

Support Intel® 6th/7th Core™ Core i3 Core i5 Core i7 Processor



Motherboard Specification

Size	170mm x 170mm
CPU	Support Intel®6th/7th Core™Corei3Corei5Corei7 Processor
Graphics	Intel HD Graphics
Chipset	Intel 6100U/6200U/6500U/7100U/7200U/7500U
Memory	1*DDR4 Slot ,2133 MHz,204 Pin,SODIMM Slot,Up to 16GB
Internal I/O	2* USB PIN,Support 3* USB2. 0 1* CPU Fan And SYS Fan 1-6 Group Serial Port PIN 1*LVDS Pin Support Dual Channel 8Bit 1*2*2 PIN Power Socket 1* SATA 1*1x12 VGA PIN Port 1*Audio Pin Port
Rear I/O	1* DC Power Input (12V) 1* HDMI 1* VGA 4*USB3.0 1* LAN 1* Mic-in/Line-out
BIOS AMI	AMIBIOS,64M bit Flash Memory
MINI_PCIE	1* Support MSATA 1* Support WiFi 3G 1*TSIM 1*M.2
SATA	1*SATA,1*MSATA
LAN	1*Realtek 8111E,10/100/1000
Audio	ALC662 Dual Channel Output
Operating System	Windows7 Windows8 Windows10 Linux
H/W Monitoring	System Power Management Temperature Management Voltage Management
Humidity	0% ~ 95% (Relative Humidity,No Condensation)
Temp	-10°C ~ 55°C

Motherboard I/O Interface Diagram

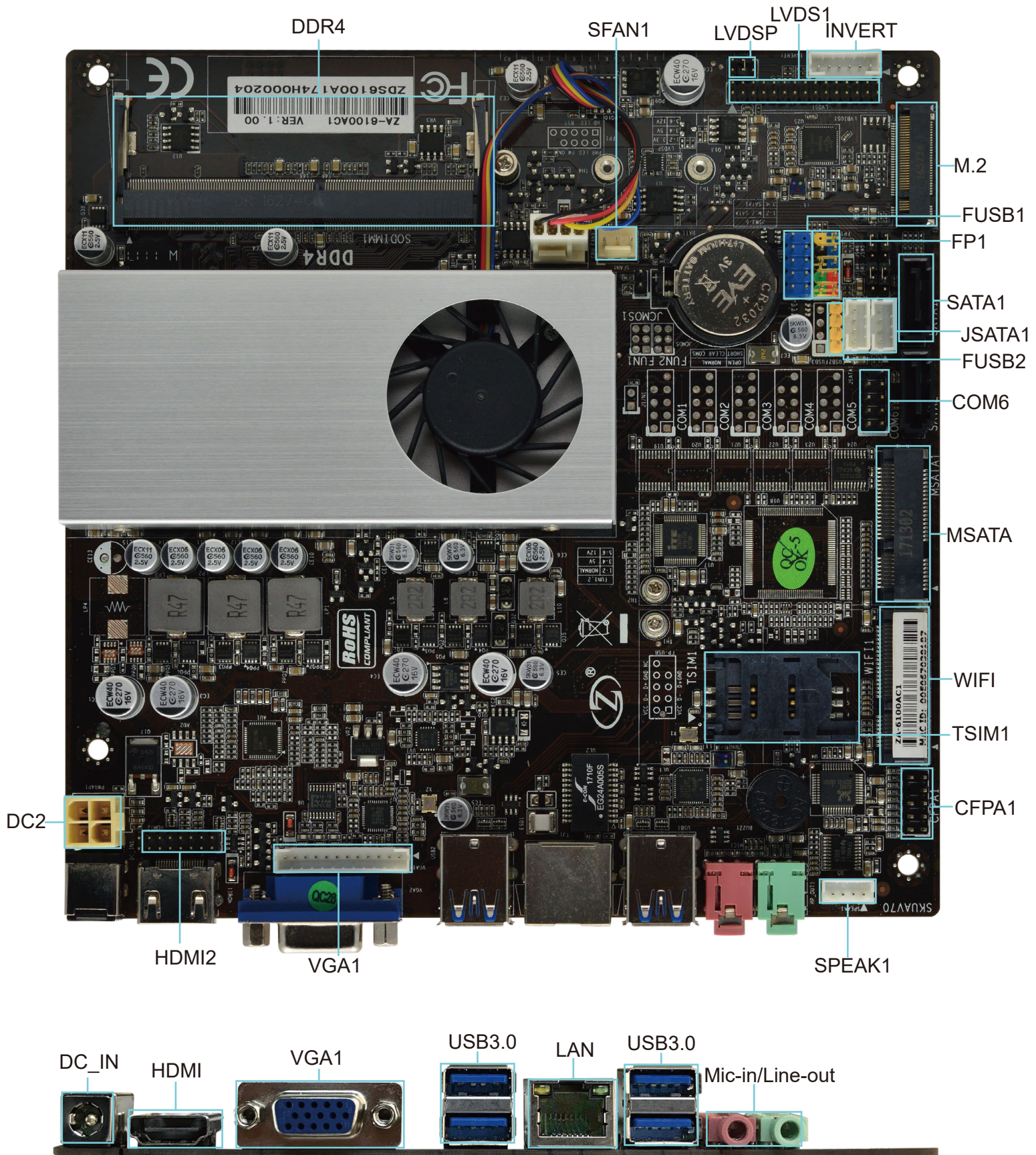

SYS_FAN
CPU_FAN

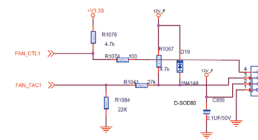
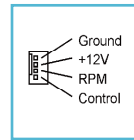

Note: these fan connectors are not jumpers, and the jumper cap is placed above the head.

DDR4

Installation memory:

1. Please turn off the power before installing or removing the memory, and dial down the AC power cord.
 2. Carefully hold both ends of the memory stick, and do not touch the metal contact above.
 3. Align the gold fingers of the memory stick with the memory stick slot, and pay attention to the convex point of the gold finger socket to the upper slot in the direction;
 4. Insert the memory stick 30 degrees into the memory slot, and then press the memory stick down to the sound of "click"
- The memory has been installed successfully and can be used (note: press down the memory bar to avoid damaging the memory too much)

Memory installation diagram (for reference only) :

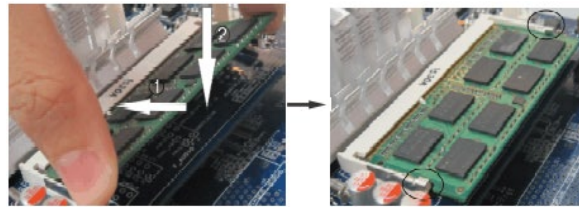

Note: static electricity damages electronic components of a computer or memory, so before following these steps, Be sure to touch the grounded metal objects briefly to remove static electricity from your body.

JSATA1

+5V 2. GND 3.GND 4.+12V

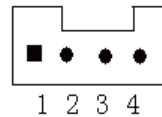

SATA 1

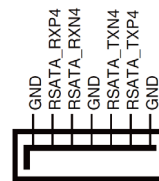

USB3.0
USB3.0

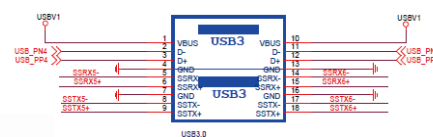

FP1

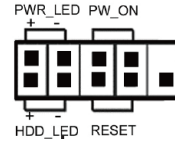
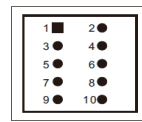

Pin	Define	Pin	Define
1	HDD LED+	2	PWR LED+
3	HDD LED-	4	GND
5	GND	6	P_SWIN
7	RESET_GND	8	GND
9	GND		

HDD Active LED:1,3 Power Button:6,8
Power LED:2,4 Reset Button:5,7

LAN

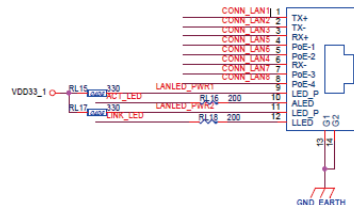

12/19VDC

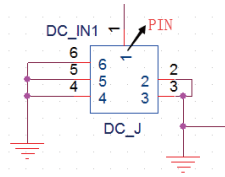

Pin	Define	Pin	Define
1	DC_IN	2	DC_J
3	GND	4	GND
5	GND	6	GND
7	GND	8	GND
9	GND		

HDMI

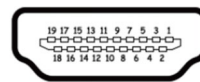

Pin	Define	Pin	Define
1	TMDS data 2+	2	TMDS data shield
3	TMDS data 2-	4	TMDS data 1+
5	TMDS data shield	6	TMDS data 2-
7	TMDS data 0+	8	TMDS data shield
9	TMDS data 0-	10	TMDS clock+
11	TMDS clock shield	12	TMDS clock-
13	CEC	14	No connectde
15	DDC clock	16	DDC data
17	Groud	18	+5V power
19	Hot plug detect		

DC1

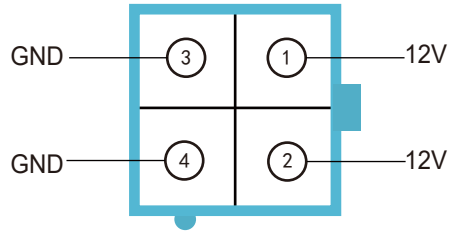

Pin	Define	Pin	Define
1	12V	2	12V
3	GND	4	GND

LVDS1

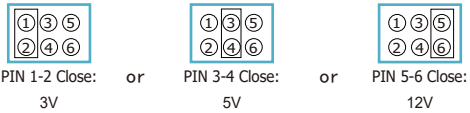

Pin	Define	Pin	Define
1	LCDVDD	2	LCDVDD
3	LCDVDD	4	GND
5	GND	6	GND
7	LVDSA_DATA0N	8	LVDSA_DATA0P
9	LVDSA_DATA1N	10	LVDSA_DATA1P
11	LVDSA_DATA2N	12	LVDSA_DATA2P
13	GND	14	GND
15	LVDSA_CLKN	16	LVDSA_CLKP
17	LVDSA_DATA3N	18	LVDSA_DATA3P
19	LVDSB_TX0N	20	LVDSB_TX0P
21	LVDSB_TX1N	22	LVDSB_TX1P
23	LVDSB_TX2N	24	LVDSB_TX2P
25	GND	26	GND
27	LVDSB_CLKN	28	LVDSB_CLKP
29	LVDSB_TX3N	30	LVDSB_TX3P

FUSB1
FUSB2

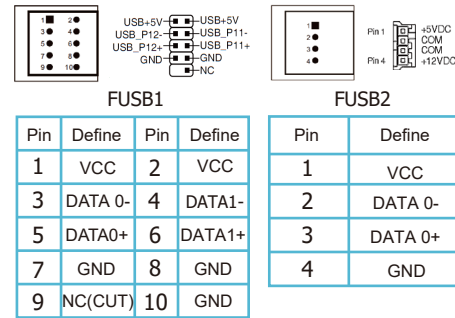

Pin	Define	Pin	Define
1	VCC	2	VCC
3	DATA 0-	4	DATA1-
5	DATA0+	6	DATA1+
7	GND	8	GND
9	NC(CUT)	10	GND

Pin	Define
1	VCC
2	DATA 0-
3	DATA 0+
4	GND

SPK1

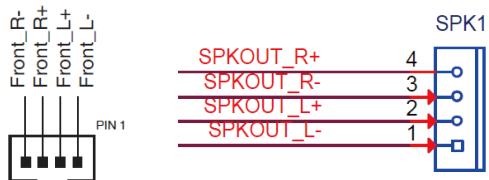

Pin	Define	Pin	Define
1	SPKOUT_L-	2	SPKOUT_L+
3	SPKOUT_R-	4	SPKOUT_R+

INVERT

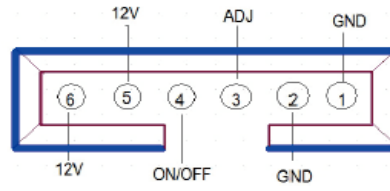

Pin	Define	Pin	Define
1	GND	2	GND
3	ON/OFF	4	ADJ
5	12V	6	12V

VGA

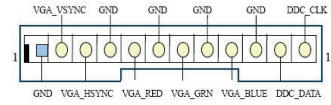

Pin	Define	Pin	Define
1	GND	2	VGA_VSYNC
3	VGA_HSYNC	4	GND
5	VGA_RED	6	GND
7	VGA_GRN	8	GND
9	VGA_BULE	10	GND
11	DDC_DATA	12	DDC_CLK

Mic-in/Line-out

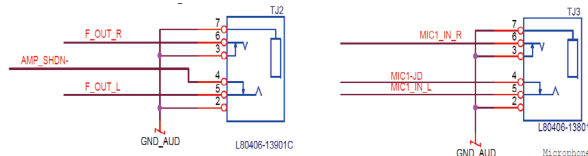

*Other Matters Please consult the sales.